

INSTRUCTION BOOKLET

DEHUMIDIFIER

type DEU322 (mod. FDD20-5162BWR5)



General Information

Thank you for buying our *Bimar DEU322* dehumidifier.

Air contains a certain amount of water in the form of vapour. This vapour determines the degree of humidity in a particular environment. As the temperature goes up, the capacity of the air to hold water vapour increases. This is why as soon as the temperature in the house drops, the air releases the water vapour that is in it, which is then deposited as condensation on cold surfaces, such as windows, walls, etc. The dehumidifier gets rid of part of the humidity from the air and stops, for example, mould or mildew forming. According to experts, the ideal conditions for our health and for the home are between 40% and 60% relative humidity.



This symbol tells you to read these instructions carefully before using the appliance, and to inform any third parties if necessary. Keep the instruction booklet for further reference throughout the lifetime of the appliance. If when reading these instructions you find any parts difficult to understand or have any doubts, contact the manufacturer at the address provided on the back page before using the product.

This symbol indicates:

Additional information in the manual.



This symbol indicates:

Service instruction: read the technical manual



This symbol highlights instructions and precautions for safe use.

This symbol indicates: :

Only use the appliance indoors.



This symbol indicates:

Caution: Fire hazard.

The appliance uses a flammable refrigerant. If the refrigerant escapes and is exposed to an external source of ignition, there is a risk of fire.



GENERAL WARNINGS

- This appliance is intended for domestic use only (therefore, it is not suitable for professional use), to purify and dehumidify, i.e. reduce the percentage of relative humidity in indoor environments, in the manner reported in this manual. Do not

- use the appliance outdoors, or in particularly dusty environments, or in the presence of extremely volatile materials which could clog the filter or damage the motor.
- This is a piece of equipment that intentionally emits and/or receives radio waves for radiocommunication and/or radiodetermination purposes.
 - Examples of household appliances are appliances for typical household functions, those used in the home, or those which may be used for typical household functions even by untrained persons:
 - in shops, offices and other similar workplaces;
 - on farms and in similar locations;
 - by the customers of hotels, motels and other residential environments;
 - in bed and breakfast establishments.
 - The appliance has been designed to work at temperatures between 5°C and 32°C.
 - Only use the dehumidifier if all the components are correctly inserted.
 - Always use the dehumidifier in an upright position only; do not sit or stand on the unit.
 - Warning: when using electrical appliances, always comply with the basic safety precautions to avoid the risks of fire, electric shock and physical injury. Greater care and precautions must be taken when using electrical appliances that are equipped with a water tank - if the water overflows or if the cord or the plug should get wet, first disconnect the device from the power socket by turning it off at the switch on the electrical panel and only unplug from the socket

afterwards. Dry both the plug and the mains cable carefully before plugging into the power socket again. If in doubt, call in qualified staff.

- This appliance can be used by children aged from 8 years and above and persons with reduced physical, sensory or mental capabilities or lack of experience or the necessary knowledge providing they are supervised or have been instructed on the safe use of the appliance and understand the hazards involved. Children must not play with the appliance. Cleaning and maintenance intended to be carried out by the user should not be done by children unless they are supervised.
- Take suitable precautions to prevent children from playing with the appliance. The appliance and all its accessories should be kept out of the reach of children.
- Do not obstruct the air inlet or air outlet grille.
- Do not insert fingers or objects into the ducts of the air inlet and outlet grilles.
- Do not touch the appliance or the plug with wet hands or feet.
- Avoid exposing body parts to the air flowing out of the appliance to avoid damages to your health.
- Unplug the appliance from the socket when not in use.
- Do not move the appliance while in operation.
- Do not pull on the power cable or the appliance itself to remove the plug from the power socket.
- Do not move the appliance by pulling the cable.

- Always disconnect the appliance from the power socket before assembling, dismantling, emptying the tank, and before cleaning the filter and the appliance.
- If the power cable is damaged, it must be replaced by the manufacturer or its technical support service, or by a person with similar qualifications, to prevent all risks.
- This appliance is not intended for operation by means of an external timer or with a separate remote control system, to avoid the risk of fire if the appliance is covered or not correctly positioned.
- Never leave the device exposed to the weather (sun, rain, etc.).
- To guard against all risk of electric shock, do not immerse the plug, the mains cable or the appliance in water or any other liquid.
- Do not drink or use the water that collects in the tank.
- Any other use constitutes misuse and is hazardous. The manufacturer cannot be held liable for any damage arising from misuse or incorrect or irresponsible use, and/or from repairs carried out by unqualified persons.

GENERAL WARNINGS

- This appliance is intended for domestic use only (therefore, it is not suitable for professional use), to dehumidify, i.e. reduce the percentage of relative humidity in indoor environments, in the manner reported in this manual. Do not use the appliance outdoors, or in particularly dusty environments, or in the presence of extremely volatile materials which could clog the filter or damage the motor.

- Examples of household appliances are appliances for typical household functions, those used in the home, or those which may be used for typical household functions even by untrained persons:
 - in shops, offices and other similar workplaces;
 - on farms and in similar locations;
 - by the customers of hotels, motels and other residential environments;
 - in bed and breakfast establishments.
- The appliance has been designed to work at temperatures between 5°C and 32°C.
- Only use the dehumidifier if all the components are correctly inserted.
- Always use the dehumidifier in an upright position only; do not sit or stand on the unit.
- Warning: when using electrical appliances, always comply with the basic safety precautions to avoid the risks of fire, electric shock and physical injury. Greater care and precautions must be taken when using electrical appliances that are equipped with a water tank - if the water overflows or if the cord or the plug should get wet, first disconnect the device from the power socket by turning it off at the switch on the electrical panel and only unplug from the socket afterwards. Dry both the plug and the mains cable carefully before plugging into the power socket again. If in doubt, call in qualified staff.
- This appliance can be used by children aged from 8 years and above and persons with reduced physical, sensory or mental capabilities or lack of experience or the necessary

knowledge providing they are supervised or have been instructed on the safe use of the appliance and understand the hazards involved. Children must not play with the appliance. Cleaning and maintenance intended to be carried out by the user should not be done by children unless they are supervised.

- Take suitable precautions to prevent children from playing with the appliance. The appliance and all its accessories should be kept out of the reach of children.
- Do not obstruct the air inlet or air outlet grille.
- Do not insert fingers or objects into the ducts of the air inlet and outlet grilles.
- Do not touch the appliance or the plug with wet hands or feet.
- Avoid exposing body parts to the air flowing out of the appliance to avoid damages to your health.
- Unplug the appliance from the socket when not in use.
- Do not move the appliance while in operation.
- Do not pull on the power cable or the appliance itself to remove the plug from the power socket.
- Do not move the appliance by pulling the cable.
- Always disconnect the appliance from the power socket before assembling, dismantling, emptying the tank, and before cleaning the filter and the appliance.
- If the power cable is damaged, it must be replaced by the manufacturer or its technical support service, or by a person with similar qualifications, to prevent all risks.

- This appliance is not intended for operation by means of an external timer or with a separate remote control system, to avoid the risk of fire if the appliance is covered or not correctly positioned.
- Never leave the device exposed to the weather (sun, rain, etc.).
- **To guard against all risk of electric shock, do not immerse the plug, the mains cable or the appliance in water or any other liquid.**
- Do not drink or use the water that collects in the tank.
- Any other use constitutes misuse and is hazardous. The manufacturer cannot be held liable for any damage arising from misuse or incorrect or irresponsible use, and/or from repairs carried out by unqualified persons.

This product contains fluorinated greenhouse gases, which are hermetically sealed. The refrigerant used is R290 and its relative global warming potential (GWP) is 3.



Additional warning for appliances with refrigerant gas R290 (refer to the data plate for the type of gas used).

Caution: Fire hazard.

Please read these instructions carefully before using the appliance. R290 is a refrigerant gas that conforms to EU environmental directives.

This appliance contains approximately 60g of R290 refrigerant gas.

The appliance must be installed, used and stored in a place with a surface area greater than 4 m².

1. WARNINGS FOR REFRIGERANT GAS R290

1.1 The equipment contains gas R290 (flammability class A3).

The amount expressed in weight and in CO₂ of fluorinated greenhouse gas for which the device is designed and the global warming potential of this gas is 60 g.

The equipment must be stored in a well ventilated location with a minimum room size of 4 m².

The equipment must be installed, used and kept in a room with a floor surface area greater than 4 m².

1.WARNING FOR R290 REFRIGERANT GAS

1.1The appliance contains R290 gas (flammability classification A3).

The appliance shall be stored in a room Without continuously operating ignition sources (for

example: open flames, an operating gas appliance or an operating electric heater).

Be aware that the refrigerants may not contain an odour. R290 is a refrigerant gas in compliance with the European directives on environment. Do not pierce any part of the refrigerant circuit.

Do not use means to accelerate the defrosting process or to clean, other than those recommended by the manufacturer. Do not use tools different from those recommended by the manufacturer

when defrosting and cleaning the appliance.

If the appliance is installed, used or stored in a non-ventilated area, the room must be designed to prevent the accumulation of refrigerant leaks with the consequent fire or explosion hazard due to the refrigerant combustion caused by electrical heaters, stoves or other sources of ignition.

Compliance with national gas regulations shall be observed.

Keep ventilation openings clear of obstruction.

The appliance shall be stored so as to prevent mechanical damage from occurring.

Any person who is involved with working on or breaking into a refrigerant circuit should hold a current valid certificate from an industry-accredited assessment authority, which authorises their competence to handle refrigerants safely in accordance with an industry recognised assessment specification.

Servicing shall only be performed as recommended by the equipment manufacturer. Maintenance and repair requiring the assistance of other skilled personnel shall be carried out under the supervision of the person competent in the use of flammable refrigerants.

Transport of equipment containing flammable refrigerants.
See transport regulations.

Marking of equipment using signs.
See local regulations.

Disposal of equipment using flammable refrigerant.
See national regulations.

Storage of equipment/appliances.

The storage of equipment should be in accordance with the manufacturer's instructions.

Storage of packed (unsold) equipment.

Storage package protection should be constructed such that mechanical damage to the equipment inside the package will not cause a leak of the refrigerant charge. The maximum number of pieces of equipment permitted to be stored together will be determined by local regulations.

Information on servicing

Checks to the area. Prior to beginning work on systems containing flammable refrigerants, safety checks are necessary to ensure that the risk of ignition is minimised.

For repair to the refrigerating system, the following precautions shall be complied with prior to conducting work on the system.

Work procedure. Work shall be undertaken under a controlled procedure so as to minimise the risk of a flammable gas or vapour being present while the work is being performed.

General work area. All maintenance staff and others working in the local area shall be instructed on the nature of work being carried out. Work in confined spaces shall be avoided. The area around the workspace shall be sectioned off. Ensure that the conditions within the area have been made safe by control of

flammable material.

1.1.5 Checking for presence of refrigerant. The area shall be checked with an appropriate refrigerant detector prior to and during work, to ensure the technician is aware of potentially flammable atmospheres. ensure that the leak detection equipment being used is suitable for use with flammable refrigerants, i.e. non-sparking, adequately sealed or intrinsically safe.

1.1.6 Presence of fire extinguisher. if any hot work is to be conducted on the refrigeration equipment or any associated parts, appropriate fire extinguishing equipment shall be available at hand.

Have a dry powder or CO2 fire extinguisher adjacent to the charging area.

1.1.7 No ignition sources. No person carrying out work in relation to a refrigeration system which involves exposing any pipe work that contains or has contained flammable refrigerant shall use any sources of ignition in such a manner that it may lead to the risk of fire or explosion.

all possible ignition sources, including cigarette smoking, should be kept sufficiently far away from the site of installation, repairing, removing and disposal, during which flammable refrigerant can possibly be released to the surrounding space. Prior to work taking place, the area around the equipment is to be surveyed to make sure that there are no flammable hazards or ignition risks. No Smoking signs shall be displayed.

1.1.8 Ventilated area. Ensure that the area is in the open or that it is adequately ventilated before breaking into the system or conducting any hot work.

a degree of ventilation shall continue during the period that the work is carried out. The ventilation should safely disperse any released refrigerant and preferably expel it externally into the atmosphere.

1.1.9 Checks to the refrigeration equipment. Where electrical components are being changed, they shall be fit for the purpose and to the correct specification. At all times the manufacturer's maintenance and service guidelines shall be followed. If in doubt consult the manufacturer's technical department for assistance.

The following checks shall be applied to installations using flammable refrigerants. The charge size is in accordance with the room size within which the refrigerant containing parts are installed; the ventilation machinery and outlets are operating adequately and are not obstructed; if an indirect refrigerating circuit is being used, the secondary circuit shall be checked for the presence of refrigerant; marking to the equipment continues to be visible and legible. markings and signs that are illegible shall be corrected; refrigeration pipe or components are installed in a position where they are unlikely to be exposed to any substance which may corrode refrigerant containing components, unless the components are constructed of materials which are inherently resistant to being corroded or are suitably protected against being so corroded.

Checks to electrical devices. Repair and maintenance to electrical components shall include initial safety checks and component inspection procedures. if a fault exists that could compromise safety, then no electrical supply shall be connected to the circuit until it is satisfactorily dealt with. if the fault cannot be corrected immediately but it is necessary to continue operation, an

adequate temporary solution shall be used. This shall be reported to the owner of the equipment so all parties are advised. initial safety checks shall include: that capacitors are discharged: this shall be done in a safe manner to avoid possibility of sparking; that there no live electrical components and wiring are exposed while charging, recovering or purging the system; that there is continuity of earth bonding.

Repairs to sealed components. During repairs to sealed components, all electrical supplies shall be disconnected from the equipment being worked upon prior to any removal of sealed covers, etc. if it is absolutely necessary to have an electrical supply to equipment during servicing, then a permanently operating form of leak detection shall be located at the most critical point to warn of a potentially hazardous situation. Particular attention shall be paid to the following to ensure that by working on electrical components, the casing is not altered in such a way that the level of protection is affected. This shall include damage to cables, excessive number of connections, terminals not made to original specification, damage to seals, incorrect fitting of glands, etc. Ensure that apparatus is mounted securely. Ensure that seals or sealing materials have not degraded such that they no longer serve the purpose of preventing the ingress of flammable atmospheres. replacement parts shall be in accordance with the manufacturer's specifications.

Repair to intrinsically safe components. Do not apply any permanent inductive or capacitance loads to the circuit without ensuring that this will not exceed the permissible voltage and current permitted for the equipment in use. Intrinsically safe components are the only types that can be worked on while live

in the presence of a flammable atmosphere. The test apparatus shall be at the correct rating. Replace components only with parts specified by the manufacturer. Other parts may result in the ignition of refrigerant in the atmosphere from a leak.

Cabling. Check that cabling will not be subject to wear, corrosion, excessive pressure, vibration, sharp edges or any other adverse environmental effects. The check shall also take into account the effects of aging or continual vibration from sources such as compressors or fans.

Detection of flammable refrigerants. Under no circumstances shall potential sources of ignition be used in the searching for or detection of refrigerant leaks. A halide torch (or any other detector using a naked flame) shall not be used.

Leak detection methods. The following leak detection methods are deemed acceptable for systems containing flammable refrigerants. Electronic leak detectors shall be used to detect flammable refrigerants, but the sensitivity may not be adequate, or may need re-calibration. (detection equipment shall be calibrated in a refrigerant-free area). Ensure that the detector is not a potential source of ignition and is suitable for the refrigerant used. Leak detection equipment shall be set at a percentage of the if of the refrigerant and shall be calibrated to the refrigerant employed and the appropriate percentage of gas (25 % maximum) is confirmed. Leak detection fluids are suitable for use with most refrigerants but the use of detergents containing chlorine shall be avoided as the chlorine may react with the refrigerant and corrode the copper pipe-work. If a leak is suspected, all naked flames shall be removed/ extinguished. If a leakage of refrigerant is found which requires brazing, all of the refrigerant shall be recovered from the system, or isolated

(by means of shut off valves) in a part of the system remote from the leak. Oxygen free nitrogen (ofn) shall then be purged through the system both before and during the brazing process.

Removal and evacuation. When breaking into the refrigerant circuit to make repairs or for any other purpose conventional procedures shall be used. However, it is important that best practice is followed since flammability is a consideration. The following procedure shall be adhered to:

Remove refrigerant;

Purge the circuit with inert gas;

Evacuate;

Purge again with inert gas;

Open the circuit by cutting or brazing.

The refrigerant charge shall be recovered into the correct recovery cylinders.

The system shall be flushed with OFN to render the unit safe.

This process may need to be repeated several times. Compressed air or oxygen shall not be used for this task.

Flushing shall be achieved by breaking the vacuum in the system with ofn and continuing to fill until the working pressure is achieved, then venting to atmosphere, and finally pulling down to a vacuum. This process shall be repeated until no refrigerant is within the system. When the final OFN charge is used, the system shall be vented down to atmospheric pressure to enable work to take place. This operation is absolutely vital if brazing operations on the pipe-work are to take place. Ensure that the outlet for the vacuum pump is not close to any ignition sources and there is ventilation available.

Charging Procedures. In addition to conventional charging procedures, the following requirements shall be followed. Ensure that contamination of different refrigerants does not occur when using charging equipment. Hoses or lines shall be as short as possible to minimise the amount of refrigerant contained in them. Cylinders shall be kept upright. Ensure that the refrigeration system is earthed prior to charging the system with refrigerant. Label the system when charging is complete (if not already). Extreme care shall be taken not to overfill the refrigeration system. Prior to recharging the system it shall be pressure tested with ofn. The system shall be leak tested on completion of charging but prior to commissioning. a follow up leak test shall be carried out prior to leaving the site.

Decommissioning. Before carrying out this procedure, it is essential that the technician is completely familiar with the equipment and all its detail. it is recommended good practice that all refrigerants are recovered safely. Prior to the task being carried out, an oil and refrigerant sample shall be taken in case analysis is required prior to re-use of reclaimed refrigerant. it is essential that electrical power is available before the task is commenced.

-Become familiar with the equipment and its operation. Isolate system electrically. Before attempting the procedure ensure that:

-Mechanical handling equipment is available, if required, for handling refrigerant cylinders;

All personal protective equipment is available and being used correctly.

-The recovery process is supervised at all times by a competent person;

-Recovery equipment and cylinders conform to the appropriate standards.

-Pump down refrigerant system, if possible.

- If a vacuum is not possible, make a manifold so that refrigerant can be removed from various parts of the system.

-Make sure that cylinder is situated on the scales before recovery takes place.

-Start the recovery machine and operate in accordance with manufacturer's instructions.

-Do not overfill cylinders. (No more than 80 % volume liquid charge).

-Do not exceed the maximum working pressure of the cylinder, even temporarily.

-When the cylinders have been filled correctly and the process completed, make sure that the cylinders and the equipment are removed from site promptly and all isolation valves on the equipment are closed off.

-Recovered refrigerant shall not be charged into another refrigeration system unless it has been cleaned and checked.

1.1.19 Labelling. Equipment shall be labelled stating that it has been de-commissioned and emptied of refrigerant. The label shall be dated and signed. Ensure that there are labels on the equipment stating the equipment contains flammable refrigerant.

1.1.20 Recovery. When removing refrigerant from a system, either for servicing or decommissioning, it is recommended good practice that all refrigerants are removed safely.

When transferring refrigerant into cylinders, ensure that only appropriate refrigerant recovery cylinders are employed.

Ensure that the correct number of cylinders for holding the total

system charge is available. All cylinders to be used are designated for the recovered refrigerant and labelled for that refrigerant (i.e. special cylinders for the recovery of refrigerant). Cylinders shall be complete with pressure relief valve and associated shut-off valves in good working order. Empty recovery cylinders are evacuated and, if possible, cooled before recovery occurs. The recovery equipment shall be in good working order with a set of instructions concerning the equipment that is at hand and shall be suitable for the recovery of flammable refrigerants. In addition, a set of calibrated weighing scales shall be available and in good working order. Hoses shall be complete with leak-free disconnect couplings and in good condition. Before using the recovery machine, check that it is in satisfactory working order, has been properly maintained and that any associated electrical components are sealed to prevent ignition in the event of a refrigerant release. Consult manufacturer if in doubt. The recovered refrigerant shall be returned to the refrigerant supplier in the correct recovery cylinder, and the relevant Waste transfer note arranged. do not mix refrigerants in recovery units and especially not in cylinders. if compressors or compressor oils are to be removed, ensure that they have been evacuated to an acceptable level to make certain that flammable refrigerant does not remain within the lubricant. The evacuation process shall be carried out prior to returning the compressor to the suppliers. Only electric heating to the compressor body shall be employed to accelerate this process.

When oil is drained from a system, it shall be carried out safely.

INSTALLATION

- After removing the packaging, check that the appliance is intact; if in doubt, do not use it and contact a qualified professional. The packaging elements (plastic bags, polystyrene, metal tacks, etc.) must not be left in reach of children or irresponsible people, as they can be dangerous. They must be disposed of according to current regulations.
- Before connecting the equipment, make certain that the plate information (voltage, etc.) correspond to the characteristics of the electricity distribution network. This appliance must be connected to a socket that has an effective earthing device (the manufacturer declines any liability that may arise from failure to comply with this rule). Check that no other appliances with a high energy consumption are connected to the power supply, to avoid overloading and the risk of fire. In general, the use of adapters, multiple sockets and/or extension leads is not recommended. If their use is unavoidable, they must comply with current safety regulations and their current capacity (amperes) must be no lower than the maximum current draw of the appliance.
- The appliance must be installed and/or placed in a location with a surface area of at least 4 m².
- Do not install the dehumidifier in environments where there are flammable products (spray cans or canisters containing gas, liquids or solids), or in dusty environments.

- Place the appliance in a vertical position, supported on all feet as well as: away from sources of heat, keep away from fabrics (curtains, hanging laundry, etc.) or anything else that might come into contact and/or obstruct the inlet and outlet grilles; keep away from bathtubs, sinks or similar, to avoid the appliance being splashed with water, or falling into these.

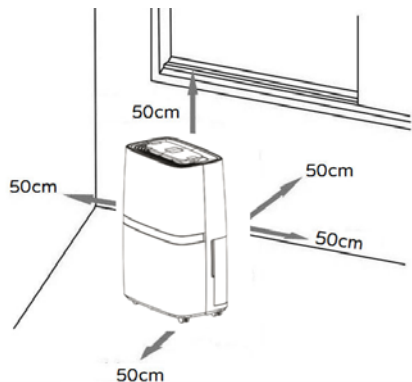

- Ensure there is a free space around the appliance of at least 50 cm.
- The appliance must be placed on a wide, strong, stable surface (do not place on a shelf), not on an incline (the water may overflow and escape), smooth (not rough) or in a place where it might be knocked.
- The appliance must not be placed just below a power socket.
- The power socket must be easily accessible so that the plug can be removed easily in an emergency.
- Make sure that the mains cable is correctly positioned and is not in contact with hot parts or sharp edges, or wound around the appliance or twisted and does not become entangled, to prevent the appliance from falling.

- If tank drainage is in use, check that the continuous drainage spout is tightly sealed with its rubber cap each time the appliance is turned on.
- If continuous drainage is on, make sure that the drainage tube is properly connected to the spout, that the opposite end is lower than the spout, and that the incline is even, so that the water flows internally without any obstructions.
- Caution: do not cover the appliance to avoid overheating.
- The appliance does not require installation, i.e. preparation of electrical attachments/water connection /fixtures or other installations, before use.
- Before each use, check that the appliance is in good condition and ensure that the power cable is not damaged.

DESCRIPTION

Wi-Fi dehumidifier that can be used with an App on a Smartphone with **Android** or **iOS** operating systems.

- Electronics with integrated Wi-Fi allowing the Smartphone-device communication via an App.
- All functions can be set-up using the App. Stand-by/I switch, Mode: Purifier / Dehumidifier with settings for Normal / Continuous / Turbo / Drying, Min / Max Fan, humidity settings (30% to 80% RH), daily and weekly programming, Sleep function, LED display with deactivation, and keypad Lock/Unlock.
- Check that the router is for domestic use, that there are no access restrictions except the password, that the Wi-Fi network is 2.4 GHz, and that there is a strong, uniform Wi-Fi signal in the room where the device is to be installed.
- Make sure that the smartphone is connected to the wi-fi network to be used for the appliance.

First Installation/Setup

1.1 Install the "BIMAR life Smart" App via Google Play (Android) or AppStore (iOS), or scan the QR code provided here.

For Android



For iOS



1.7 Once installed, the app icon appears. Click the "Bimar Live Smart" icon to run the app.



1.8 The first time the app is started, register and enter your credentials:
 - click "Register" and confirm the "Privacy Policy Statement" with "I agree" to continue

- enter your phone number or email address (select the mode in the top right-hand corner)
- click "Get check code", wait a few moments and then enter the code received in the registration email or text message in the "Check code" field (also check in the Spam folder if you cannot find the email in your "Incoming Mail" folder).
- 1.9 Enter the password required and click "Done".
- 1.10A screen will open: click "Create Family".

1.11 A screen (as shown on the right) appears where you can customise the home (name, position and name of room). Confirm when done.

- 1.7 Once you have customised the app correctly, the main screen appears. It contains the following functions:
- List and control of devices, subdivided by room "🏠"
 - List and control of scenarios "☀️"
 - User profile management "👤"
 - Pairing of new devices "+"

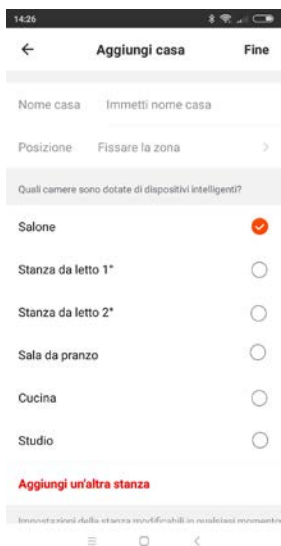

2. To pair new devices with the smartphone

2.7 Insert the plug in the power outlet. There is an audible "beep". Press the "PROGRAMMI DEUMIDIFICATORE" button for about five seconds. There is an audible "beep" and the "📶" light flashes quickly. Release the button.

2.8 Open APP on the smartphone: in the first screen, click "ADD DEVICE" or click "+" in the top right corner.



2.9 In the next screen, click "Deumidificatore".

Confermare che il LED lampeggia velocemente

2.10 In the next screen, click " /Check that the LED flashes quickly.



The device can also be paired in the “AP Mode”, pressing the button on the top right.



Press and hold the “ ” button for about five seconds. There is an audible

“beep” and the “ ” indicator light flashes quickly. Release the button. Open the telephone’s Wi-Fi settings and connect to the “Bimar Live Smart xxx” or “Smart Life xxx” network. Then press “connect now”.



2.11 In the next screen, “Set Wi-Fi” (see below), type the **PASSWORD** of your Wi-Fi network and click the “confirm” symbol to activate the connection. The countdown (see below) starts and will be interrupted as soon as the smartphone has connected to the device.

2.12 The first screen reappears with the added option “**DEHUMIDIFIER**” (see figure); click “**DONE**” to activate the appliance.

The device can also be shared with other users. (See next section: Description of fan heater control panel or Use via smartphone)



If the above operations do not proceed correctly, the device must be reset by disconnecting the plug from the power socket and leaving the device disconnected for 30 seconds. Insert





the plug in the device's power outlet again, press the “PROGRAMMI DEUMIFICATORE” button for about five seconds. There is an audible "beep" and the “” light flashes quickly. Release the button.

Settings and customisations.

Open the smartphone screen and press  in the bottom right corner to customise the following functions:

- Home management
- Message centre
- Assistance centre
- Configure (audio, alerts, info, cache memory clear)

Press  in the bottom centre to customise operation of the device to suit the various scenarios or operating situations provided by the APP (for example: Back home, Leaving home, Dawn, Goodnight, Temperature, Humidity, Weather, Air quality, Dawn/dusk) or in combination with other devices.

Press  in the bottom left corner and then in the top of the screen, for example:

 to customise (update and/or change where permitted) the appliance's position or the outdoor wind speed, air pressure, humidity and temperature (see right).



Press  top right to customise the following:

- Change Device name
- Device position
- Check Network
- Third-party devices supported: Amazon Alexa, Google Assistant
- Device sharing
- Create a Comment group
- Device Info
- Feedback
- Update Firmware
- Remove device
- Restore Factory Settings

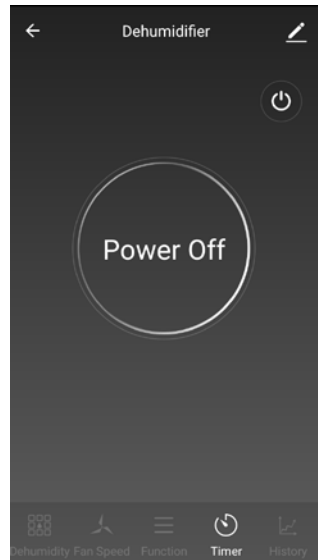

The smartphone must be connected to Wi-Fi or cellular data network for remote control.

Description of device control panel or Use via smartphone (Follow the procedure in point 1.1)







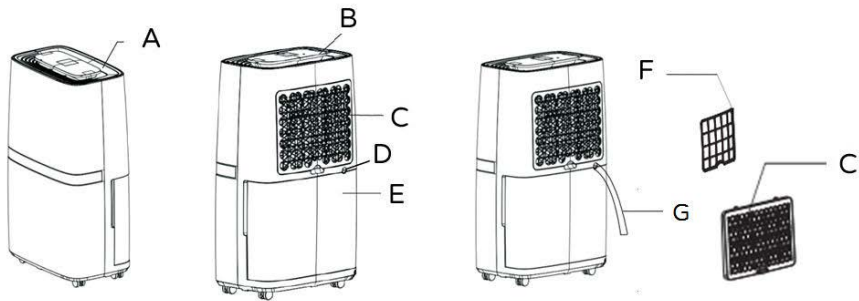

DESCRIPTION



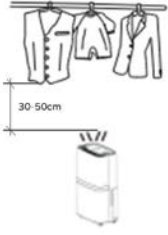



The appliance is equipped with the following parts and elements for control and regulation: control panel (A), Removable tank (E), Air outlet grille (C), Filter (F), Continuous drainage spout (D) and Continuous drainage tube (G).



Control Panel

	On/Off Button	Turns on the appliance and puts on standby. The fan starts up after a few moments and then the compressor starts up (if necessary).
	Program key	Select dehumidification: Normal / Continuous / Turbo / Drying: it is active only when the appliance is already powered on. When selecting the program, the corresponding LED flashes for about five seconds and then the selected function appears:
<ul style="list-style-type: none"> - “ ”: Normal. It is possible to select: timer, humidity interval or desired fan using the buttons. - “ ”: Continuous: the appliance operates with minimum fan power. Timer can be selected, but it is not possible to select the humidity interval. - “ ”: Turbo: the appliance operates continuously with maximum fan power. Timer can be selected, but it is not possible to select the humidity interval. 		

	<p>: Drying. The dehumidifier operates at maximum speed, the humidity level is automatically set based on the ambient humidity. This program is recommended in very humid environments or to dry clothing (this function optimizes the drying process). Before hanging out the clothing, check that they have gone through the spin cycle or wring them by hand, so that they have lost most of the water.</p>									
<p>For the best air flow, align the clothing and leave space between the garments. Do not hang very wet or thick garments directly in front of the air outlet. Check that the clearance between the clothing and the appliance is at least 30 to 50 cm (see the figure), and that there is at least 50 mm open space around the appliance. The drying process performance depends on:</p> <ul style="list-style-type: none"> - the type of fabric (cotton, synthetic, etc.) - the amount of humidity remaining after the spin cycle - the quality of the garment - the amount of drying required <p>Optimum drying performance may not be possible for thick or heavy garments.</p>										
	<p>Humidity Level</p>	<p>Select the relative humidity button (HR%). This function only works when on “Normal” mode. Press the button to select 30 to 80 HR% (the pre-set value is 50%): each time it is pressed, it increases by 5%. The value can be viewed on the display, which after a few moments shows the current value (precision $\pm 5\%$). When the equipment reaches the set degree of humidity: the dehumidifier goes into stand-by (the compressor turns off) and the fan motor continues to operate for about 3 minutes. When the ambient humidity is greater than the set humidity, the dehumidifier turns on once again. Press the key for about 3 seconds to display the ambient temperature. After a few instants, the display will return to the relative humidity.</p>								
	<p>Luminous display of relative humidity.</p> <table border="1" data-bbox="375 1034 1002 1157"> <thead> <tr> <th>Colour</th> <th>Relative humidity level (HR%).</th> </tr> </thead> <tbody> <tr> <td>Blue</td> <td><50</td> </tr> <tr> <td>Green</td> <td>(50-70)</td> </tr> <tr> <td>Red</td> <td>>70</td> </tr> </tbody> </table>		Colour	Relative humidity level (HR%).	Blue	<50	Green	(50-70)	Red	>70
Colour	Relative humidity level (HR%).									
Blue	<50									
Green	(50-70)									
Red	>70									
	<p>Fan Button</p>	<p>Select the fan: “Max” or “Min”, when selected, the corresponding LED turns on:</p> <p>Maximum:  and Minimum: </p>								
	<p>Air Purifier button</p>	<p>Selects the air purifier. The equipment operates continuously, purifying the air thanks to the on-board filter.</p>								

		This selection allows setting the minimum or maximum speed, and the timer.
	Night button	Selecting night operation deactivates the display and the LEDs. The only the “  ” LED remains on, as well as full tank when it is active.
	Timer Button	<p>This times the appliance operation or start-up: each time the button is pressed, the time increases by one hour, up to a maximum of 24 hours. If pressed again, the time is cancelled (0:0 appears).</p> <p>Start-up Timer: with the appliance in stand-by, press the button until the desired time is reached (1 to 24 h). The time blinks for about five seconds and then it is possible to set the programs and fans. On the display, the “” and “” indicators appear. Once the time set passes, the timer starts the appliance in the previously set mode.</p> <p>Operation Timer: activate the appliance, set the programming and fans, then select the timer for the desired time (1 to 24 h). The time flashes for about five seconds. Once the time set on the timer has been reached, the appliance turns off.</p>
	Loc/unlock button	To lock the control panel buttons, press the button for about three seconds and the indicator light on the button turns on. To unlock the use of the buttons, repeat the operations in reverse order.
<ul style="list-style-type: none"> Weekly programming (only activate via Smartphone): sets: the on/off periods for each day of the week, dehumidifier programmes, fan speed, and humidity levels. For the on / off periods, select the time (hours and minutes) and confirm the operation (on or off) and then the next (off or on). The periods can be repeated during the week. Dehumidifier programs (normal, continuous, turbo and drying), and select the fan and humidity level when allowed (see the details described previously). Consult the log (only possible with Smartphone display): temperature and humidity for each day/month/year during use. 		
Automatic defrost	<p>During dehumidification, the defrost function is activated based on the ambient temperature (T.A.):</p> <ul style="list-style-type: none"> - With T.A. 24 °C or greater, defrost is not activated. - With T.A. between 18 °C and 23 °C, defrost is activated every 2 h and lasts for 5 min. - With T.A. between 12 °C and 17 °C, defrost is activated every 25 min and lasts for 5 min. - With T.A. between 5 °C and 11 °C, defrost is activated every 20 min and lasts for 5 min. <p>NOTES: Do not turn off or disconnect the power cable during defrost. - During defrost, dehumidification and air purification, they can be intermittent.</p>	

	Tank gauge	Indicates that the tank is full. If the tank is not inserted correctly, the indicator light turns on but no “beep” is heard and the appliance will only operate for a few minutes before the dehumidifier turns off.
---	-------------------	---

Draining

The water can be drained:

3. Via the tank (E). The water condensate is collected in the tank and when the tank is full, the float inside puts the appliance in stand-by

and the  indicator light turns on. Remove the tank without spilling any water, empty it and dry it. Check that the chain is fully closed, and replace the tank correctly in its seat (after a few seconds the tank full LED turns off).



4. Continuous

The continuous drainage spout is located on the back of the appliance. Connect the rubber tube with an internal diameter of 10 mm and maximum length of 30 cm (comes supplied with some models). Make sure the connection does not leak. Check that the drain is at a lower height than the spout and that the whole tube is sloping evenly and that it is lower than the spout.

Do not remove the water tank from its place. If continuous drainage is not in use, remove the drainage tube.

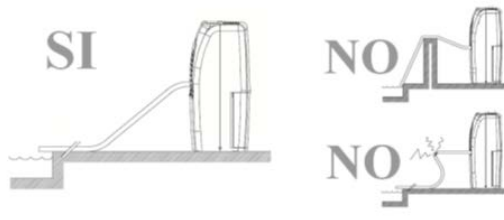
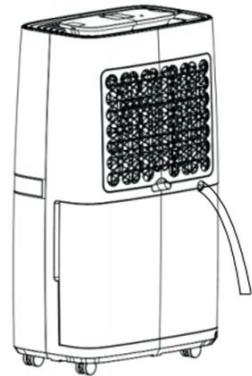

Filter

The air inlet grille has a filter which traps dust: it is located inside and the grille must be removed to access it.

See the paragraph below for filter maintenance.



Handle

There is a handle on the top, for transportation.

USE

Before each use, make sure that:

- the appliance is in good condition
- that the mains cable is not damaged
- that the tank is empty, and fully in place.
- that for continuous water drainage, the drain tube is properly connected to the spout and positioned correctly whenever continuous drainage is used.

- Connect the plug to the power socket.
- Turn on the appliance by pressing the “” button and activate the desired function, following the instructions above.
- When removing the tank, the dehumidifier will stop the compressor and then the fan will stop: the appliance is now on standby. Once it is back in place, the appliance will automatically start in a few moments.
- To deactivate the appliance, press the “” button. Go to standby and to switch it off completely, remove the plug from the power socket.
- Except when ventilating the environment, keep windows and doors closed, to maximise the effects of the dehumidifier.

During long periods of inactivity, remove the plug from the electric socket.

CLEANING AND MAINTENANCE

Warning: disconnect the plug from the power socket before routine cleaning. Keep the appliance in an upright position during cleaning.

• Filter

It is advisable to clean the filter periodically (approximately every two weeks max or more often if the appliance is used daily).

To remove the filter, remove the intake grille. To remove the dust build-up, use a brush or a vacuum cleaner. Be careful not to damage any part of it. If the filter is very dirty, wash it in warm water and rinse it a few times. The water temperature must not exceed 40 °C. After washing, leave it to dry fully before returning it to its proper seat. Never wash in the dishwasher.

• Tank

It is advisable to empty it after every use and wash it periodically to avoid the formation of bacteria or unpleasant smells. To clean the tank, use lukewarm water with a regular detergent for crockery (do not use abrasives, solvents or similar), wash it and replace it into position.

- **Main Unit**

Wash only with a soft cloth dampened with water.

- When not in use for long periods, empty the water from the tank, wind the cable around the cord winder, store in an upright position, away from dust and humidity, and respecting the precautions set out in the warnings section.
- If you decide not to use the appliance any more, it must be rendered unusable by cutting off the power supply cord (first making sure that the plug has been removed from the power socket), and any parts which are hazardous if used as children's playthings must be rendered harmless.
- Do not attempt to replace or repair any components on your own. Contact the service company if needed.

- **Gas R290**

Please be reminded to follow the instructions in the warnings section.

Information for correct disposal of the product under the European Directive 2011/65/EU.

At the end of its lifetime, the product must not be disposed of with ordinary urban waste.

It can be consigned to the special waste recycling centres provided by local government, or by the retailers who provide this service.

To avoid possible damages to the environment or human health due to the uncontrolled disposal of waste, recycle the equipment in a responsible manner, promoting the sustainable reuse of material resources, refrigerants and flammable insulating gases.

Proper disposal of a household appliance prevents possible detrimental effects on the environment or health arising from its incorrect disposal and allows the recovery of its constituent materials, generating major savings of energy and resources. The product bears the crossed-out symbol of a wheeled rubbish bin to indicate that it must be disposed of separately. Illegal dumping of the product by the user will be subject to prosecution under the relevant law.



TROUBLESHOOTING

Problem	Possible reason	Solution
If the fan and compressor do not work.	The appliance is not on.	Turn on the appliance.
	The electrical socket is defective.	Seek advice from a qualified professional.
	The plug is not connected to the socket.	Connect the plug to the power socket.
	The tank full gauge is on.	Empty the water tank.
	The water tank is not properly inserted, tank full light gauge is on.	Reposition the tank.
The appliance does not dehumidify or does not dehumidify adequately.	The air filter is clogged.	Clean the filter as described in the section, "Cleaning and Maintenance".
	The windows and doors of the room are open.	Close the windows and doors of the room.
	The room temperature is too low.	Automatic defrosting is in operation; the appliance will start dehumidifying again once it stops.
	The time is not long enough to extract the humidity.	Increase the time.
	The air inlet or outlet grille is covered or blocked.	Make sure that the grilles are free.
The dehumidifier is excessively noisy.	The dehumidifier is not correctly positioned or is not tilted and/or is unstable.	Position the dehumidifier on a flat stable surface.
	The air filter is clogged or incorrectly inserted in its guides.	Clean the filter as described in the section, "Cleaning and Maintenance". Check that it is set in its guides correctly.



Via G.Amendola, 16/18
25019 Sirmione (BS) – ITALY
www.bimaritaly.it

Servizio clienti:



info@bimaritaly.it